

Description

The E3 is a high resolution rotary encoder with a molded polycarbonate enclosure, which utilizes either a 5-pin locking or standard connector. This optical incremental encoder is designed to easily mount to and dismount from an existing shaft to provide digital feedback information.

The E3 is easy to add to existing applications and only consists of four main components; base, cover, hub/code wheel and optical encoder module.

The E3 is normally designed for applications of 6 feet or less. For longer cable lengths, adding a PC4 / PC5 differential line driver is recommended.

The base and cover are both constructed of rugged 20% glass filled polycarbonate. Attachment of the base to a surface may be accomplished by utilizing one of several machine screw bolt circle options. Positioning of the base to the centerline of a shaft is ensured by use of a centering tool (sold separately). The cover is securely attached to the base with two 4-40 flat head screws to provide a resilient package protecting the internal components.

The internal components consist of a shatterproof mylar disk mounted to a precision machined aluminum hub and an encoder module. The hub is available for diameters up to 1". The module consists of a highly collimated solid state light source and monolithic phased array sensor, which together provide a system extremely tolerant to mechanical misalignments.

Connection to the E3 product is made through either a 5-pin locking or standard connector (sold separately). The mating connectors are available from US Digital with several cable options and lengths.



Features

- Quick, simple assembly and disassembly
- Rugged screw-together housing
- Accepts .010" axial shaft play
- Tracks from 0 to 100,000 cycles/sec
- Small size
- 64 to 2500 cycles per revolution (CPR)
- 256 to 10,000 pulses per revolution (PPR)
- 2 channel quadrature TTL squarewave outputs
- Optional index (3rd channel)
- -40 to +100C operating temperature

Related Products & Accessories

- CA-C5-SH-C5 5-Pin Standard / Standard Shielded Cable (Base price \$11.50)
- CA-C5-SH-FC5 5-Pin Standard / Latching Shielded Cable (Base price \$14.13)
- CA-C5-SH-NC 5-Pin Standard / Unterminated Shielded Cable (Base price \$6.25)
- CA-C5-SS-MD6 5-Pin Standard / 6-Pin Modular Silver Satin Cable (Base price \$10.48)
- CA-C5-W4-NC 5-Pin Standard / Unterminated 4-Wire Cable (Base price \$5.75)
- CA-C5-W5-NC 5-Pin Standard / Unterminated 5-Wire Discrete Cable (Base price \$5.75)
- CA-FC5-SH-LC5 5-Pin Latching / Locking Shielded Cable (Base price \$16.76)
- CA-LC5-SH-LC5 5-Pin Locking / Locking Shielded Cable (Base price \$16.76)
- CA-LC5-SH-NC 5-Pin Locking / Unterminated Shielded Cable (Base price \$8.88)
- CA-LC5-SS-MD6 5-Pin Locking / 6-Pin Modular Silver Satin Cable (Base price \$13.11)
- CA-LC5-W4-NC 5-Pin Locking / Unterminated 4-Wire Discrete Cable (Base price \$8.38)
- CA-LC5-W5-NC 5-Pin Locking / Unterminated 5-Wire Discrete Cable (Base price \$8.38)
- CON-C5 5-Pin Standard Connector (Base price \$1.05)
- CON-LC5 5-Pin Locking Connector (Base price \$3.15)
- CTOOL Centering Tool for E2, E3, E5, E6, and E7P (Base price \$5.25)
- HEXD-050 Hex Driver - .050" (Base price \$5.25)
- HEXW Hex Wrench (Base price \$0.53)

- ▶ SCREW Threaded Fasteners (Base price \$0.26)
- ▶ SPACER Spacer Tool (Base price \$0.95)

 **Mechanical Drawing**

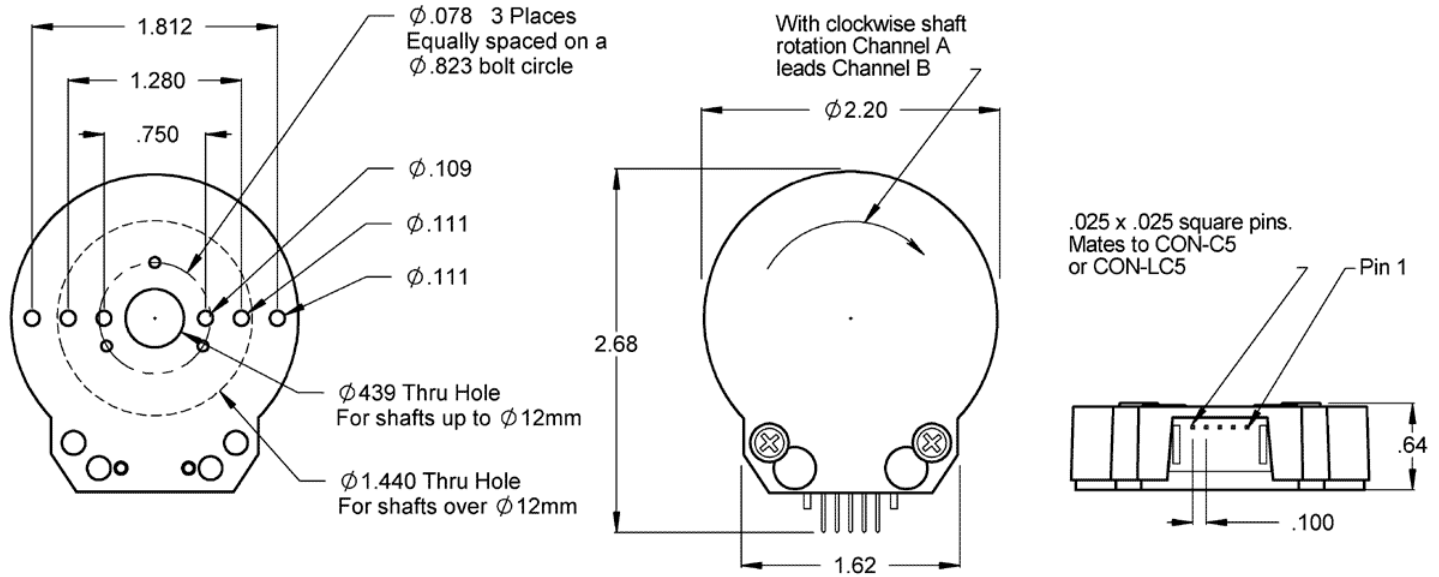

 **Mechanical**

Parameter	Dimension	Units
Encoder Base Plate Thickness	.135	in.
3 Mounting Screw Size	0-80	in.
3 Screw Bolt Circle Diameter	.823 ±.005*	in.
2 Mounting Screw Size	2-56 or 4-40	in.
2 Screw Bolt Circle Diameter	.750 ±.005	in.
2 Screw Bolt Circle Diameter	1.280 ±.005	in.
2 Screw Bolt Circle Diameter	1.812 ±.005	in.
Required Shaft Length	.445 to .525**	in.
With E -option*	.445 to .670**	in.
With H -option	>.445**	in.

* Only for shaft diameters <.472".

** Add .125" to the required shaft length when using **M**-option.

 **Absolute Maximum Ratings**

Parameter	Max.	Units
-----------	------	-------

Vibration (5 to 2kHz)	20	g
Shaft Axial Play	0.01	in.
Shaft Eccentricity Plus Radial Play	0.004	in.
Acceleration	250,000	rad/sec ²
Maximum RPM e.x. CPR = 2500, max. rpm = 2400 e.x. CPR = 1000, max. rpm = 6000 e.x. CPR = 64, max. rpm = 60000	minimum value of (6000000/CPR) and (60000)	rpm

- Note that radial play translates directly to position inaccuracy.
- Note: 60000 rpm is the maximum rpm due to mechanical considerations. The maximum rpm due to the module's 100kHz maximum count frequency is (6000000/CPR).

Phase Relationship

A leads B for clockwise shaft rotation, and B leads A for counterclockwise rotation viewed from the cover/label side of the encoder (see the *EM1 / HEDS* page).

Electrical

- Specifications apply over entire operating temperature range.
- Typical values are specified at $V_{cc} = 5.0V_{dc}$ and $25^{\circ}C$.
- For complete details see the EM1 and HEDS product pages.

Resolution	Supply Current	Output voltage low	Output voltage high	Based on
	Typ / Max	Max	Min	
100, 200, 400, 500, 512, 1000, 1024 CPR, non-index	17 / 40 mA	0.4 volts @ 3.2mA	2.4 volts @ -200uA	Low-res HEDS
2000, 2048 CPR, non-index	57 / 85 mA	0.5 volts @ 8mA	2.4 volts @ -40uA	High-res HEDS
64 CPR, with index	27 / 30 mA	0.5 volts @ 8mA	2.0 volts @ -8mA	EM1
100, 200, 400, 500, 1000, 1024 CPR, with index	57 / 85 mA	0.5 volts @ 8mA	2.4 volts @ -40uA	High-res HEDS
1800 CPR, with index	55 / 57 mA	0.5 volts @ 8mA	2.0 volts @ -8mA	EM1
2000, 2048 CPR, with index	57 / 85 mA	0.5 volts @ 8mA	2.4 volts @ -40uA	High-res HEDS
2500 CPR, with index	55 / 57 mA	0.5 volts @ 8mA	2.0 volts @ -8mA	EM1

Torque Specifications

Parameter

Torque

Hub Set Screw to Shaft	2-3 in.-lbs.
Cover (4-40 screws through cover into base)	2-3 in.-lbs.
Base to Mounting Surface	4-6 in.-lbs.
Base to Mounting Adapter Plate	4-6 in.-lbs.
Adapter Plate to Mounting Surface (4-40 screws)	4-6 in.-lbs.
Adapter Plate to Mounting Surface (6-32 screws)	6-8 in.-lbs.

Module Identification

Be sure to keep different diameters, resolutions and options separated. The resolution of the optoelectronic modules and the code wheels must match. Index and non-index parts cannot be mixed since the optical patterns are different. An identifier is stamped on each optoelectronic module.

For Agilent Modules (HEDS): The 2-channel (non-index) version can be identified by a 9100 or 9200. The 3-channel (index) version can be identified by a 9140. One suffix letter specifies the resolution as shown in the table below.

For US Digital Modules (EM1): The first number identifies the size of the disk this module is to be used with. The second number identifies the resolution as shown in the table below. The 3-channel (index) version is standard and not denoted unless the module is non-index. The 2-channel (non-index) can be identified by a -N.

Disk	Standard	Index
64	-	2-64
100	S	S
200	C	C
400	E	E
500	E	F
512	A	-
1000	B	B
1024	J	J
1800	-	2-1800
2000	T	T
2048	U	T
2500	2-2500-N	2-2500

Pin-out

Pin	Description
1	Ground
2	Index

Pin	Description
3	A channel
4	+5VDC power
5	B channel

Options

Index

Provides a single pulse per revolution.



3-option

3-option makes all five of these hole diameters .125". If desired, the two .096" diameter recesses will mate with matching aligning pins. The .438" diameter center hole can also mate with a motor boss. If a motor boss is lacking, a centering tool is usually required to mount the base in proper position to the shaft.



E-option

The E-option provides a cylindrical extension to the cover allowing for longer shafts of up .670". This option is only for shaft diameters <.472".



H-option

The H-option adds a hole to the cover for the shaft to pass through.

- Shafts <=1/2", a 0.55" diameter hole is supplied.
- Shafts >1/2", a 1.05" diameter hole is supplied.



M-option

These adapter plates are for mounting to a 3" diameter bolt circle. Use two 4-40 x 1/4" screws (sold separately) to attach the E3 base to the plate. Comes attached when ordered with encoder.



T-option

When mounting holes are not available, a pre-applied transfer adhesive (with peel-off backing) is available for "stick-on" mounting. Use the centering tool (sold separately) to slide the base into position. **T-option** specifies transfer adhesive on the standard mounting base.

Instructions: To use transfer adhesive, peel off paper backing and slip tool into center hole of the base and slide both down shaft as one piece. Press to form a good bond, then slip tool off and continue with the standard mounting instructions. A centering tool is highly recommended when using transfer adhesive.

 **E3 Assembly Instructions**

For Shafts Greater Than 0.394" (10mm):

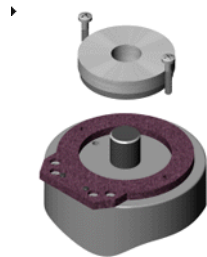

1. Base Mounting

Secure the base to the mounting surface using two or three screws (sold separately). If a centering tool is used, slip it over the shaft and into the center hole of the base. Tighten the mounting screws and then remove the centering tool.

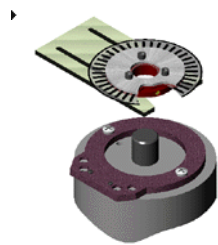

2. Spacer Installation

Push the spacer tool onto the bottom section of the hub/disk assembly. Make sure the spacer tool snaps only on the lower part of the hub. Align hub set screws as shown in drawing.

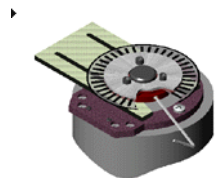

3. Hub/Disk Assembly Installation

Slip the hub over the shaft until it bottoms out against the spacer tool. Make sure the spacer tool clears the mounting screws on the base. Tighten both set screws with the hex wrench provided while pressing down on the hub. Remove the spacer tool.

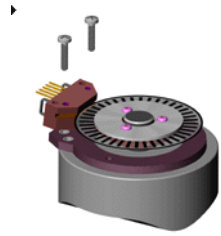

4. Encoder Module Installation

Orientate the module with the connector pins toward the top. Slide the module from front to back, being careful not to damage the disk. Stop when the two alignment pins on the base fit into the holes of the module. Secure with two 4-40 1/2" pan head screws (supplied).

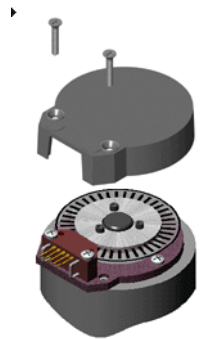

5. Cover Installation

Place the cover over the assembly and secure with the two 4-40 5/8" flat head screws (supplied).

For Shafts Less Than or Equal To 0.394" (10mm):

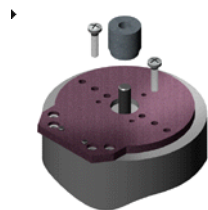

1. Base Mounting

Secure the base to the mounting surface using two or three screws (sold separately). If a centering tool is used, slip it over the shaft and into the center hole of the base. Tighten the mounting screws and then remove the centering tool.

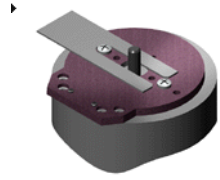

2. Spacer Installation

Place the spacer tool around the shaft, flat on the base.

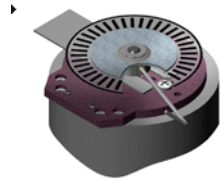

3. Hub/Disk Assembly Installation

Slip the hub over the shaft until it bottoms out against the spacer tool. Tighten the set screw with the hex wrench provided while pressing down on the hub. Remove the spacer tool.

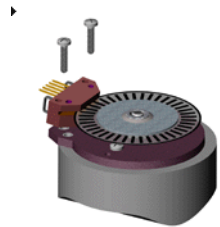

4. Encoder Module Installation

Orientate the module with the connector pins toward the top. Slide the module from front to back, being careful not to damage the disk. Stop when the two alignment pins on the base fit into the holes of the module. Secure with two 4-40 1/2" pan head screws (supplied).

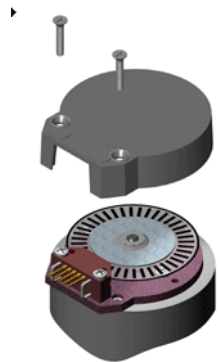

5. Cover Installation

Place the cover over the assembly and secure with the two 4-40 5/8" flat head screws provided.

Accessories

Centering Tools

* May need to order separately, only included with **PKG3**-packaging option.

Part #: CTOOL - (Shaft Diameter)

Description: This reusable tool provides a simple method for accurately centering the E3 base onto the shaft in order to promote concentricity and thus, higher accuracy. It is recommended for the following situations:

- When using mounting screws smaller than 4-40.
- When the position of the mounting holes is in question.
- When using the 3-hole mounting pattern.
- When using the T-option transfer adhesive.

Instructions: When mounting encoder base, slide centering tool down shaft until it slips into centering hole of encoder base. Tighten mounting screws, then remove centering tool.

Hex Tools

* May need to order separately, see below for more information.

Part #: HEXD-050

Description: Hex driver, .050" flat-to-flat for 3-48 or 4-48 set screws. Only included with **default** or **PKG1**-packaging options.

Part #: HEXW-050

Description: Hex wrench, .050" flat-to-flat for 3-48 or 4-48 set screws. Only included with **PKG2** or **PKG3**-packaging options.

Spacer Tools

* May need to order separately, see below for more information.

Part #: SPACER-265

Description: For shafts $\leq .394$ ".

Part #: SPACER-260

Description: For shaft sizes 12MM or 1/2 IN.

Part #: SPACER-555

Description: For shafts $\geq .551$ ".

Screws

* For **base mounting** only, screws for mounting the housing to the base are already included.

Part #: SCREW-080-250-PH

Description: Pan Head, Cross Drive 0-80 UNF x 1/4"

Quantity Required for Mounting: 3 per encoder

Part #: SCREW-256-250-PH

Description: Pan Head, Cross Drive 2-56 UNC x 1/4"

Quantity Required for Mounting: 2 per encoder

Part #: SCREW-440-250-PH

Description: Pan Head, Cross Drive 4-40 UNC x 1/4"

Quantity Required for Mounting: 2 per encoder

 **Ordering Information**

E3 - - - - - -

CPR	Bore	Index	Cover	Base	Packaging
64	079 =	N =No Index	D =Default	D =Default	B =Encoder components packaged in bulk.
100	2mm	I =Index (3rd channel)	E =Cover Extension	3 =Base Mounting Holes become .125"	One spacer tool and one hex driver per 100 encoders
200	118 =		H =Hole in Cover	M =4-hole mounting adapter plate	1 =Each encoder packaged individually. One spacer tool and one hex driver per 100 encoders.
400	3mm			T =Transfer Adhesive	2 =Each encoder packaged individually with one spacer tool and one hex wrench per encoder.
500	125 = 1/8"				3 =Each encoder packaged individually with one spacer tool, one hex wrench, and one centering tool per encoder.
512	156 =				
1000	5/32"				
1024	157 =				
1800	4mm				
2000	188 =				
2048	3/16"				
2500	197 =				
	5mm				
	236 =				
	6mm				
	250 = 1/4"				
	313 =				
	5/16"				
	315 =				
	8mm				
	375 = 3/8"				
	394 =				
	10mm				
	472 =				
	12mm				
	500 = 1/2"				
	551 =				
	14mm				
	625 = 5/8"				
	750 = 3/4"				
	875 = 7/8"				
	984 =				
	25mm				
	1000 = 1"				

Rules

- Index must be equal to I when CPR is 64, 1800 or 2500
- Base must be something other than 3 when Bore is 472
- Cover must be something other than E when Bore is 394

Notes

- US Digital warrants its products against defects in materials and workmanship for two years. See complete warranty for details.

Base Pricing

Quantity	Price
1	\$61.95
10	\$54.93
50	\$49.25
100	\$45.83

- Add \$12.00 per unit for **Bore** of 12mm , 1/2" , 14mm , 5/8"
- Add \$16.00 per unit for **Bore** of 3/4" , 7/8" , 25mm or 1"
- Add \$7.00 per unit for **Base** of 4-hole mounting adapter plate
- Add \$6.00 per unit for **Base** of Transfer Adhesive
- Add \$3.00 per unit for **Packaging** of Each encoder packaged individually. One spacer tool and one hex driver per 100 encoders.
- Add \$4.00 per unit for **Packaging** of Each encoder packaged individually with one spacer tool and one hex wrench per encoder.
- Add 18% per unit for **Index** of I or **CPR** greater than or equal to 1000.
- Add \$7.00 per unit for **Packaging** of 3, \$13.00 per unit if the bore size is greater than 394